

PLAN VIEW

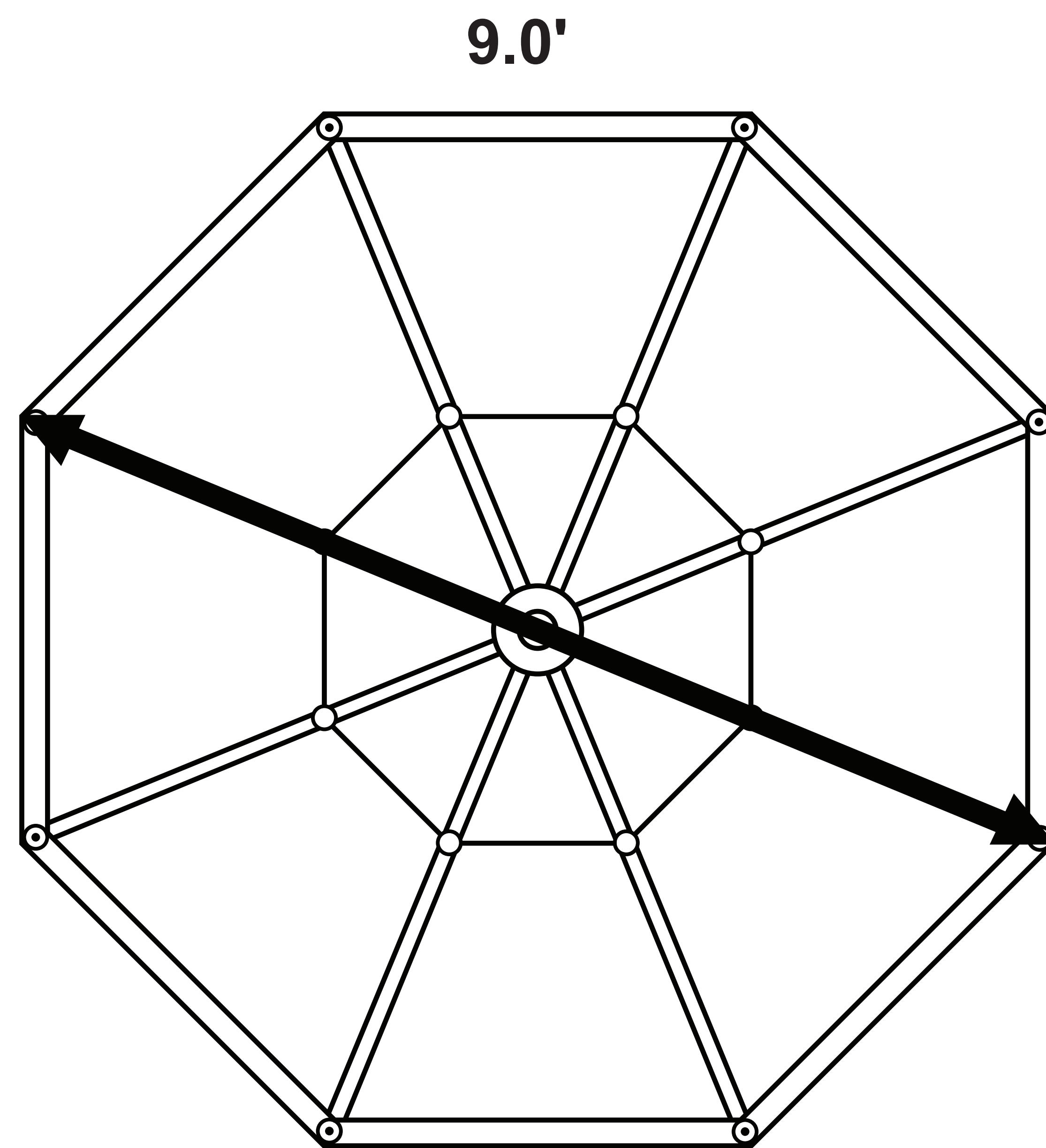

- **9' OCTAGON**
- **FIBERGLASS RIBS 5/8" DIAM**
- **ALUMINUM POLE 1 1/2" AND 2" DIAM**

FRONT ELEVATION



A

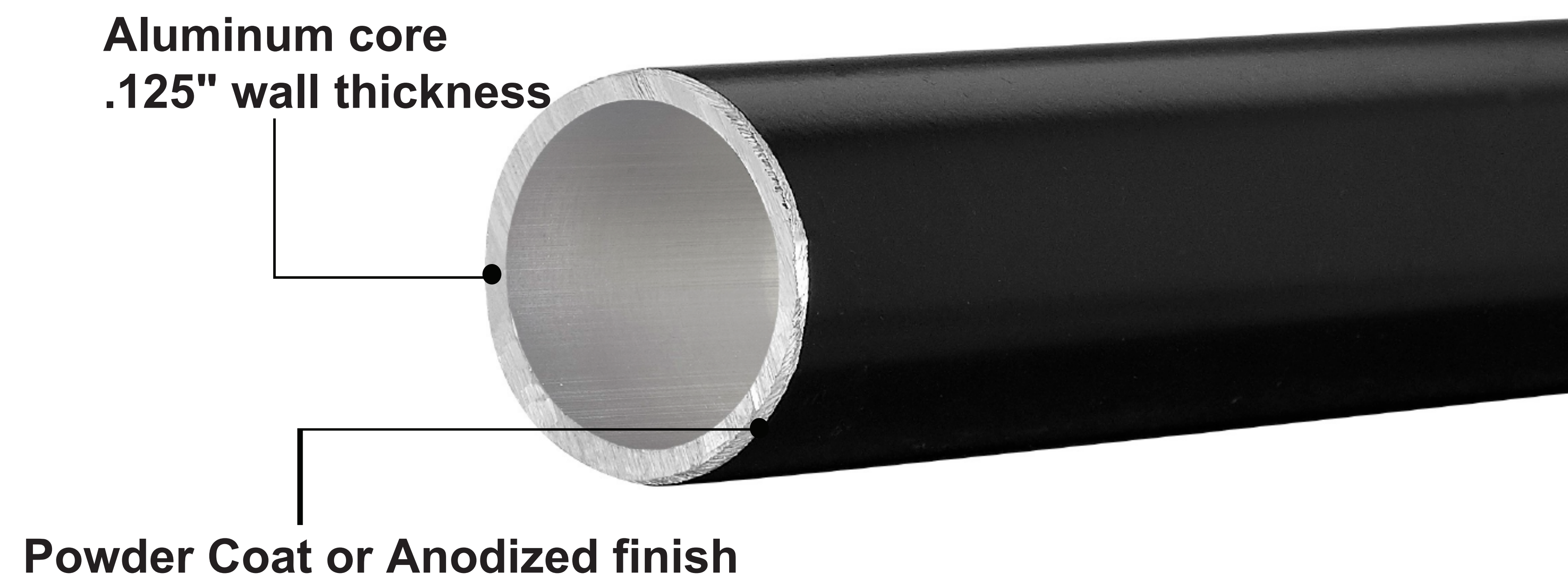

DETAIL A
INTERNAL VIEW
OF POLE CONSTRUCTION

COMPONENTS

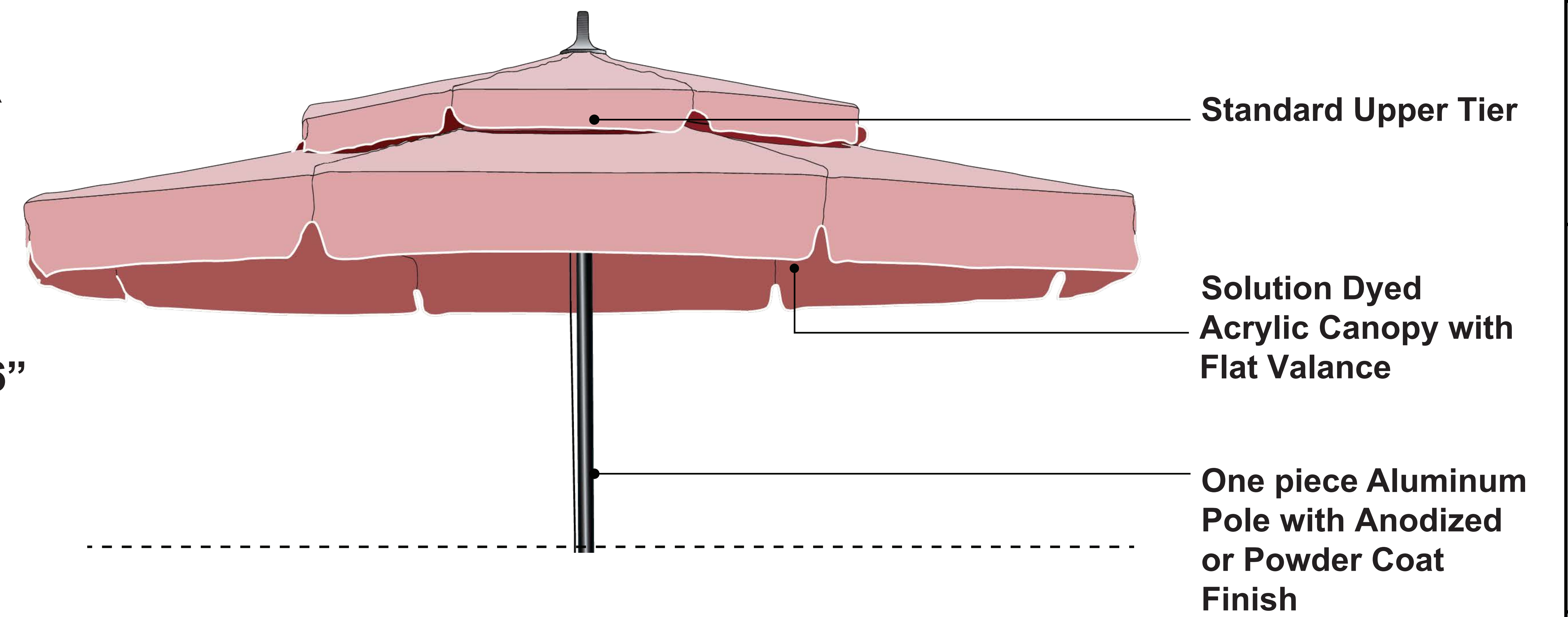

B

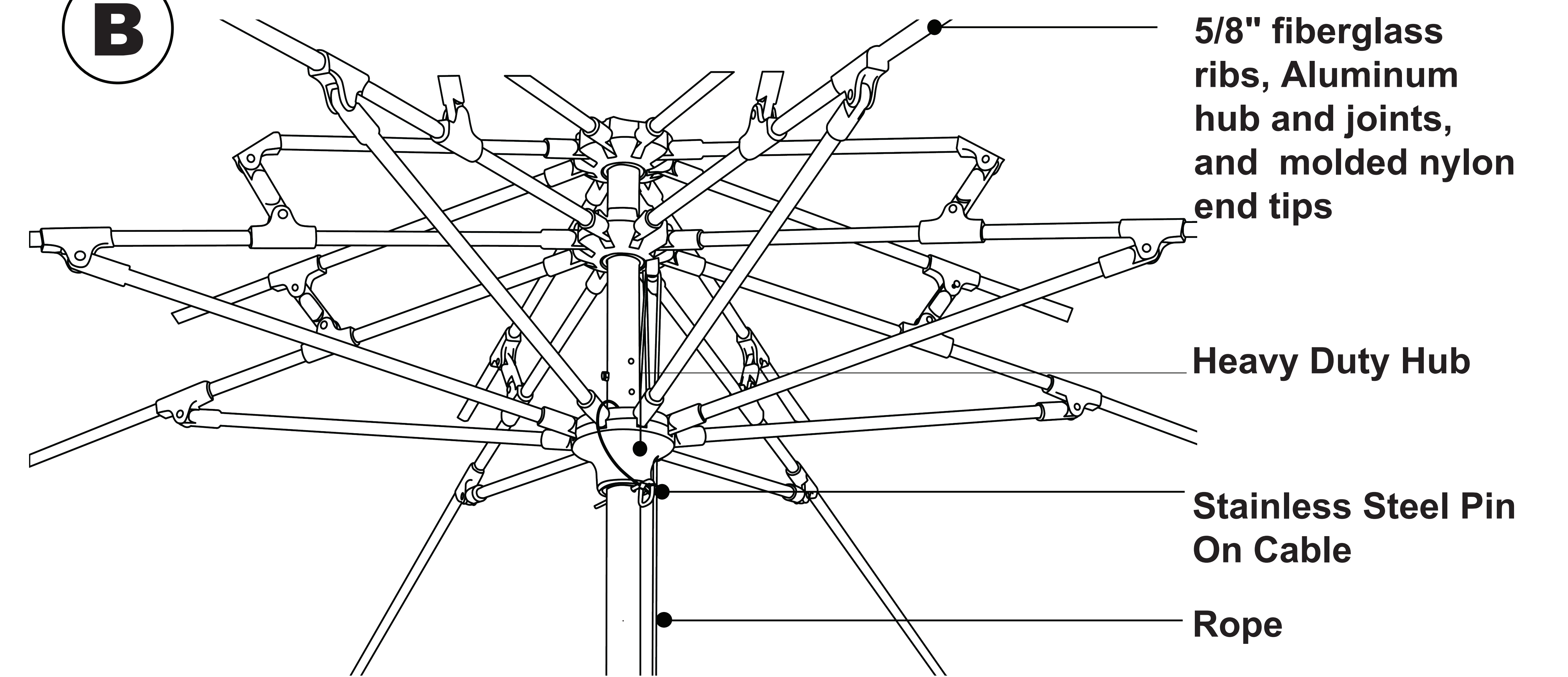

DETAIL B
RIB, HUB AND PULLEY
ASSEMBLY

GENERAL NOTES:

1. All Dimensions Are In Inches.
2. 93% Manufactured In The **USA**.

Available Sizes

9' oct with Locking Pulley Lift
Height: 96"
Weight: 28 lbs



PRESTIGE COLLECTION
MODEL: PHOENIX OCTAGON
DRAWING DATE: 2026

PLAN VIEW

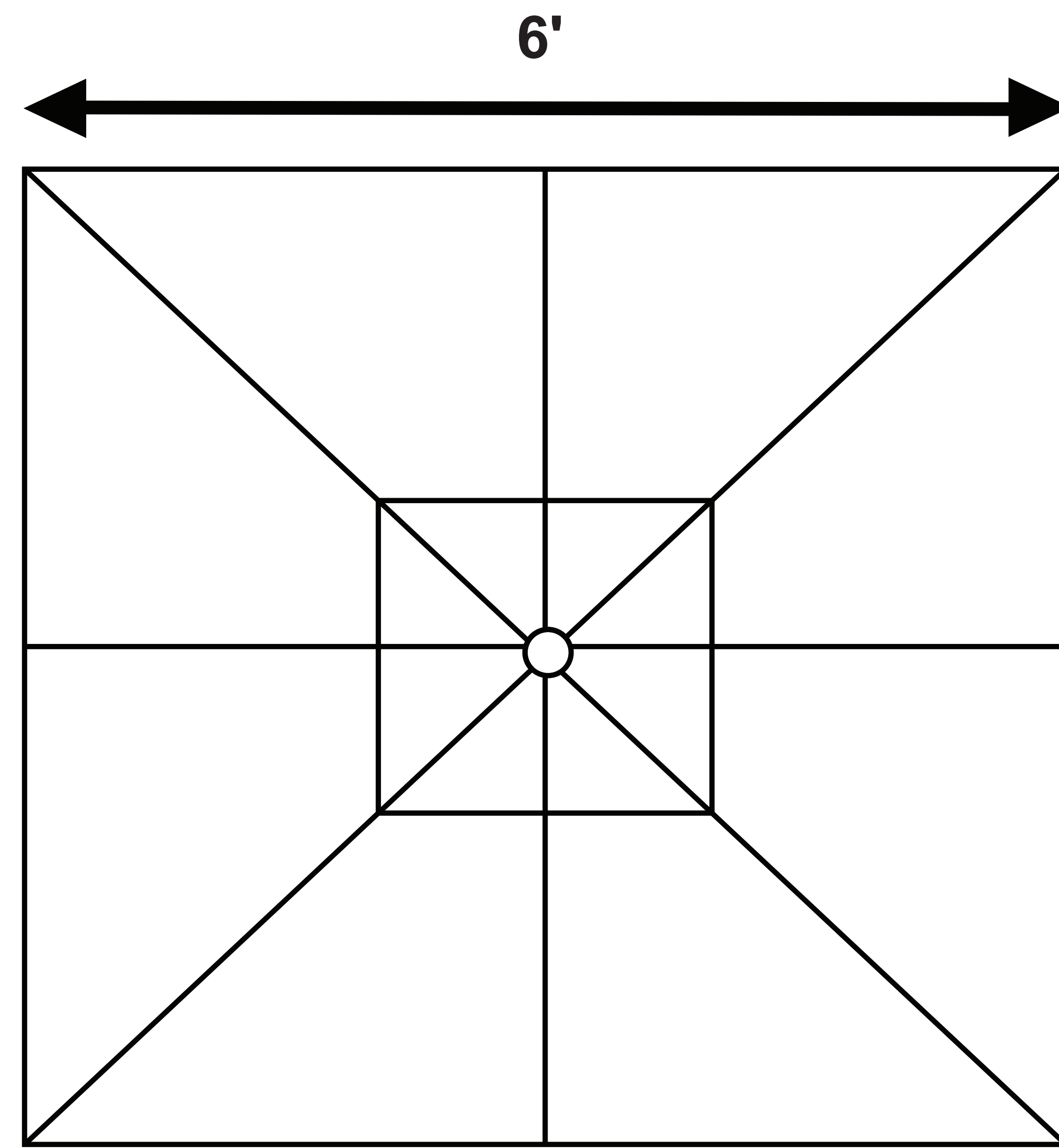

- 6' SQUARE
- FIBERGLASS RIBS 5/8" DIAM
- ALUMINUM POLE 1 1/2" AND 2" DIAM

FRONT ELEVATION



COMPONENTS

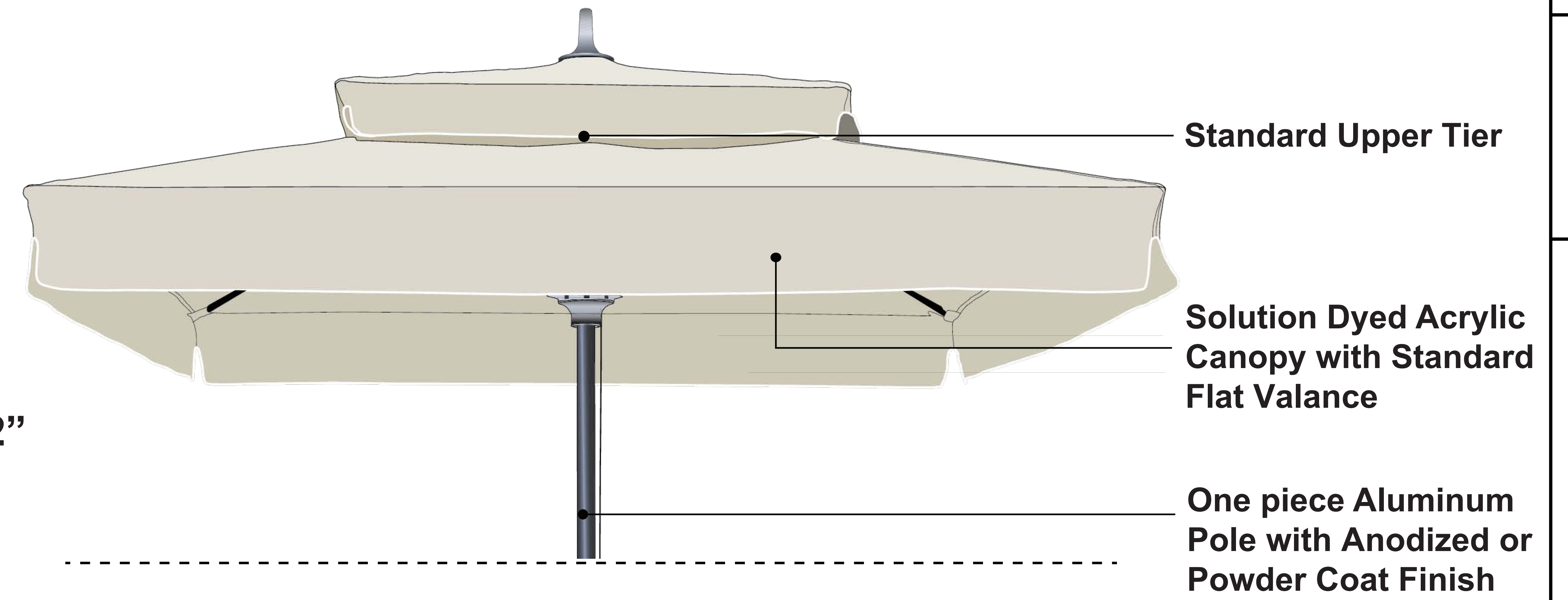

A

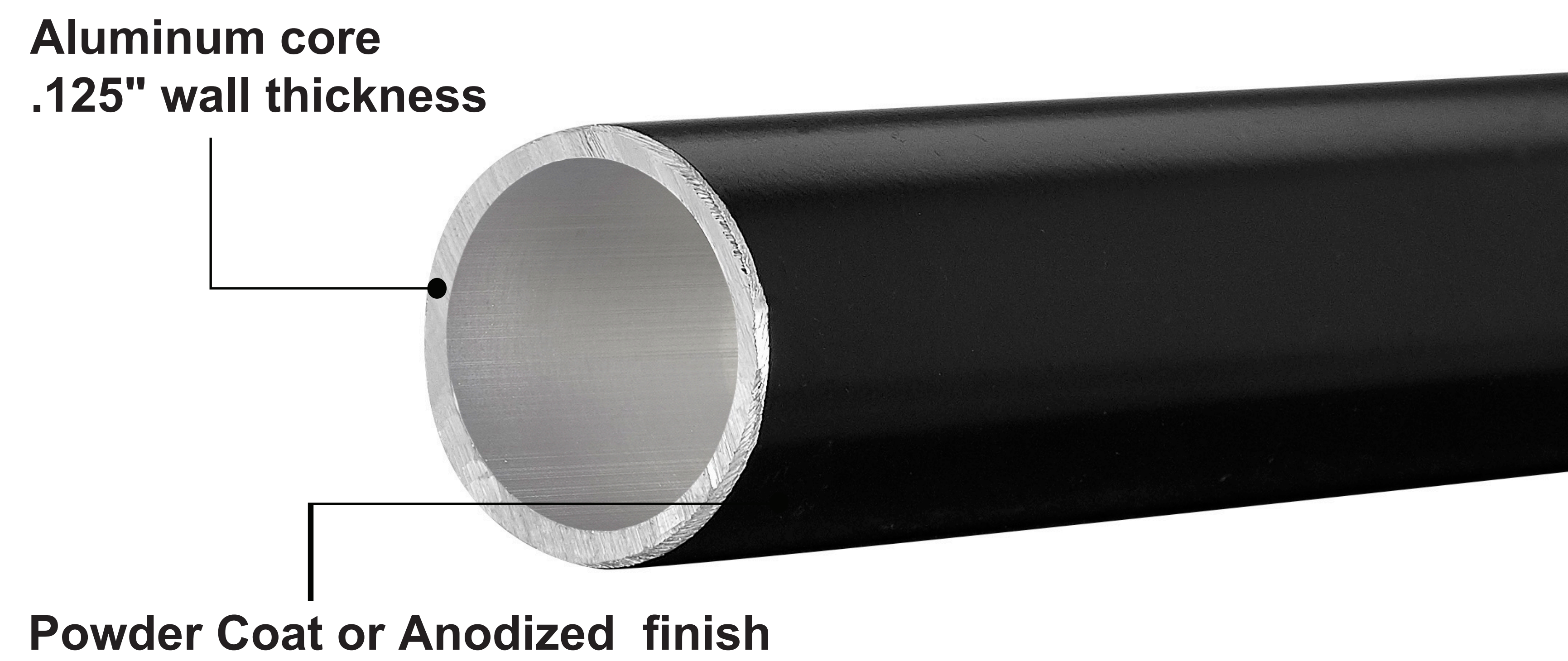

DETAIL A
INTERNAL VIEW
OF POLE CONSTRUCTION

B

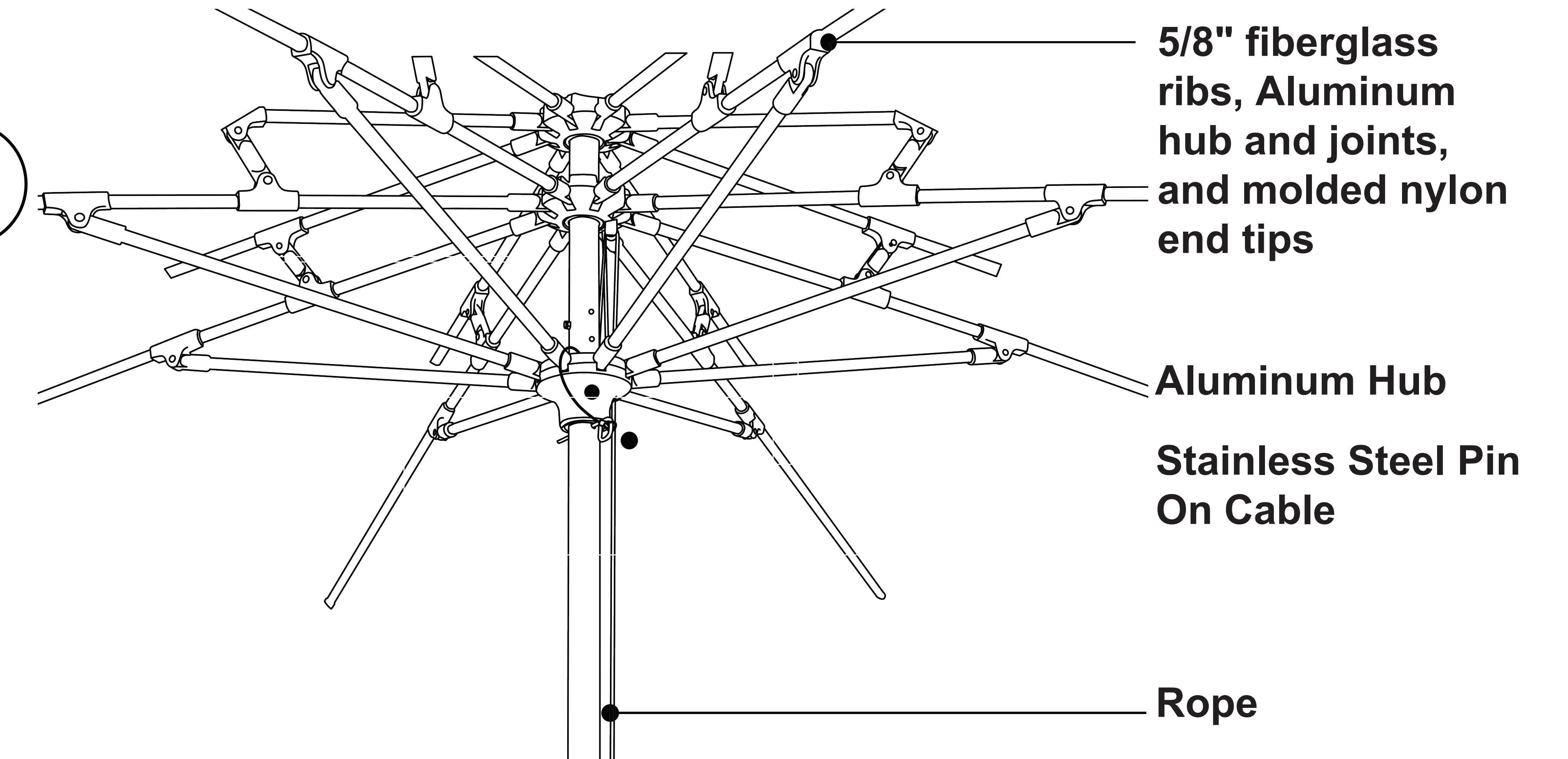

DETAIL B
RIB, HUB AND PULLEY
ASSEMBLY

GENERAL NOTES:

1. All Dimensions Are In Inches.
2. 93% Manufactured In The USA.

Available Sizes

6' sq with Locking Pulley Lift
Height: 102"
Weight: 38 lbs



PRESTIGE COLLECTION
MODEL: PHOENIX SQUARE
DRAWING DATE: 2026